



MD 3000W~5000W

使用手册

版权说明

引 语

? 6ž

†

†

? 6ž

\$

公司简介

\$" "&

Zffb,!!i i i ž_ Sj bZafa` [Uežla_



, Zffb,!!i i i ž_ Sj bZafa` [Uežla_
, &" "Ž+" "Ž+' **
, Ł*(Ž)' ' Ž@(* (+%)
, [Xa2 _ Sj bZafa` [Uežla_

#

..... 4

..... 5

#ž ' ,

\$ž ((

%ž ((

&ž))

' ž ## ##

..... 12

#ž # \$ \$

\$ž # \$ \$

%ž # % %

&ž # % %

' ž # % %

(ž # & &

) ž # ' '

..... 16

#ž # ((

\$ž #))

%ž #))

&ž # + +

..... 20

#ž \$ " "

\$Ž		\$#
	22
#Ž		\$\$
\$Ž		\$\$
%Ž		%%
&Ž		\$&
' Ž		\$(
(Ž		\$)
) Ž		\$)
* Ž		%'
	31
#Ž		%#
\$Ž		%%\$
	35
#Ž		%
\$Ž		%
	37
#Ž		%@
\$Ž		%@
	38
#Ž		%*
\$Ž		%*

第一章 特性说明

? 6ž

+#" ž+%` _ 7+(' ž+*` _



0&` .

? 6

5'See &

第二章 安全信息

1 -

? 6ž

+#" ž+%` _ Ł+(' ž+*` _

2-

1.

2.

>SeW H[e[a` GE3 =W fW] 5adbadSf[a` DaUZi W^>SeWd;` Vgefd[Vé

3-

7@ ('' "## ' "' +Ł3# \$" #"

5;EBD ## ' "' +Ł3# \$" #"

855 5^See 3

7@ (#" "" ž%ž\$, ' "' (Ł3#, ' "' +Ł3\$, ' "' +

7@ (#" "" ž%žq, ' "' *

7@ (#%\$(ž#, ' "' (

7@ (#" " " Ž&Ž\$, ' " " +
 7@ (#" " " Ž&Ž% ' " " (Ł3#, ' " ") Ł3\$, \$" #"
 7@ (#" " " Ž&Ž&, ' " " &Ł3#, \$" #"
 7@ (#" " " Ž&Ž , ' " " (
 7@ (#" " " Ž&Ž(, ' " " +
 7@ (#" " " Ž&Ž# #, \$" &

3 ;57EŽ " " %

7@ (#" # " Ž#, ' " " #

7@ (" * \$' Ž#, ' " ")

56D: \$# 58D # " &" Ž#"

7@ ;EA #%" &+Ž# ' " " *Ł3# ' " " + 5SfŽ%! B>V

? 6 Ž 57 7? 5
 7? 5 6[dWUf]hW 7? 5 7@' ' " ##
 7@(#%\$(Ž# ' " " (7@' ' " ## # 3

? 6 5'See & \$# 58D
 < # " &" Ž#" V

5'See & 7@ (" * \$' Ž

+

4 -

1.

2.

? 6ž

3.

#

\$

%

&

,

(

)

*

+

#"

##

4.

#

\$

%

&

% " H35

,

(

)

% " H35

5.

#

\$

"

5-

>SeWd;` ef[fgfWaX3_ Wd[US/;>3fi
 #% " # ;` YW g[fk 6d[hW Eg[fW#\$*
 Ad`S` Vat8`ad[VS %\$* \$(
 BZa` W&") %*" #' ' %8Sj , &") %*" ' ' *
 Fa^8dWV# *"" %& >3E7D
 3_ Wd[US` @Sf[a` S^EfS` VSdVe;` ef[fgfW
 3@E; L#%(#1 3_ Wd[US` @Sf[a` S^EfS` VSdV XadfZWESXWGeWaX>SeVde
 /3hS[`ST`WFZ dgYZ >;3fi
 ;` fWd Sf[a` S^7`WUfda ZWUZ` [US^5a_ _ [ee[a`
 ;75 (" *\$` Z#17V[f[a` #Z\$
 5W fWdXad6Vh[UW`S` V DSV[a`aY[US^: V\$`fZ
 \$# 58D # " & " z#" ZBWad_ S` UWEfS` VSdVe Xad>[YZfZ7_ [ff[` Y BdaVgUfe
 GE 6VbSdf_ W f aX>STadZAE: 3
 BgT f[USf[a` *Z#z) Z9g[VW[` V`e Xad>SeWdESXWk S` V : SI SdV 3eeVee_ W fZ
 >SeWdESXWk 7cg[b_ W f
 >Sgd[` BgT f[eZ[` Y
 >SeWdeSXWk Vcg[b_ W f S` V 4gkVd e 9g[VV`e

3-

? 6Z%" ""	%" ""
? 6Z&" ""	&" ""
? 6Z " ""	' "" ""

4-

5-



急停开关

/A 88 A @fi	
/7? 7D97@5K EFABfi	
/EF 3DF fi	
3>3D?	
35F;H7	
BAI 7D	

6-



5FD>	
DE\$%\$	DE\$%\$
35%*	%* " H
BAI 7D	
I 3F7D AGF	
I 3F7D ;@	
ABF;53> AGFBGF	

7-

1.

C4:

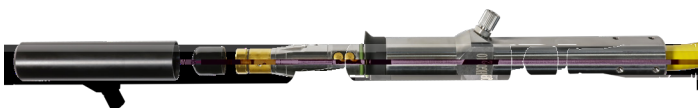

第四章 详细规格

1-

#							!
\$							
%	? 6ž%	#" " "		%" " "			
	? 6ž&" " "	#" " "		&" " "			
	? 6ž " " "	#" " "		' " " "			
&			#"		#" "	."	
'		#" " "	+#" "	+\$" "	+%"	、 —	
			+(' "	+)'" "	+*" "		
(%/4	#" " "		%	'	、 —	
)		#" " "	O#Z	f #	f %	."	
*		#" " "	O\$&Z	f \$	f ' "	."	
+	4BB	(" " "	—	&" "	&' "	— — j — dV	
#"		#" " "	+ " " "	' " "	#" " "	e	
##		+ " " "	#" " "	' " "	#" " "	e	
#\$		#" " "			\$" "	=:	
##%		#" " "		#" " "			
#&				#' "		—	
#'				(" " "		—	
#(\$" " "		—	
#)				C4:			

2-

#			%"	%*"	&"	H35
\$		%" " 2 # " " .)	=
		&" " " 2 # " " .			+	=
		' " " " 2 # " " .			##	=
%		#"	\$'	&"		
&		#"		*'	.	
,						
(ž#"	\$'	("	
)		+ ' " f &* \$ž(f#) \$ f 6ft				--
*) * f %]Y

3-

#						
\$		%" " ž# " " "	\$(\$*	
		\$' " " ž(" " "	\$\$		\$&	
%		%" " !' " "	#"			> _ [
		* " " !# " " "	#\$			
		#' " "	#'			
		\$' " "	%			
		&" " "	&\$			
		(" " "	('			

&	% " ! ' "	\$#			-
	* " ! # " "	%'			
	# ' " "	%*			
	\$ ' " "	&'			
	& " " "	&'			
	(" " "	' %			
,	% " ! ' " "	\$: B
	* " ! # " " "	\$Z			
	# ' " "	%			
	\$ ' " "	&			
	& " " "	'			
	(" " "	*			

	# " _	\$ " _	% " _	& " _	' " _	(" _) " _	* " _	+ " _	+ ' _
# "	Z\$ "	Z# #Z+	Z(Z*	Z/ā'	" Z(\$Z(&Z*) Z(* Z&	+Z\$
# '	Z#(Z&	Z) Z+	Z\$Z&	#Z	&Z)) Z%	+Z(#Z Z(#Z/ā&	#&Z\$
\$ "	Z#\$Z	Z/ā)	#Z+	(Z'	+Z\$'	#Z\$Z'	#&Z&	#(Z&	#* Z%	#+Z\$
\$ '	Z* Z)	" Z	(Z\$	# " Z	#Z/ā*	#(Z)	#+Z#	\$Z Z%	Z/ā\$	\$&Z#
% "	Z Z'	&Z(# " Z	# ' Z'	#* Z&	#Z&	Z/ā+	\$(Z\$	\$* Z\$	\$+Z#
& "	\$Z(#Z)	#+Z#	Z/ā*	\$) Z(% Z)	Z/ā	% Z+	%* Z'	%+Z'
' "	# " Z'	\$ " Z'	\$) Z(Z/āZ(%(Z)	& " Z'	Z/ā'	& Z(&) Z+	&+Z'

4-

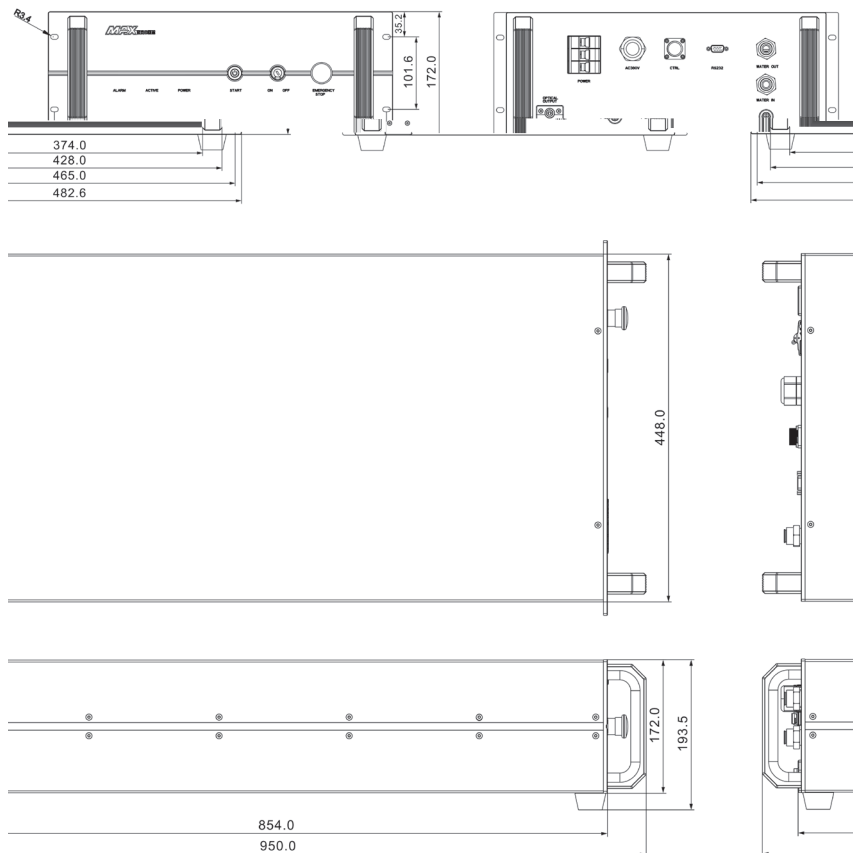

第五章 拆装指南

1-

#

\$

%

OS" " _ _

&

,

(

2-

	? 6Z%""!&""!""	I	#
%* " H35	%		#
	%Z		#
DE\$\$	DE\$\$		#
DE\$\$ GE4	, /G@;F7=fi ,KZ#" *† ,8F\$\$		#
			\$
G	* 9		#
			&
	#\$j #" _ _		#
	? 6		#

第六章 使用指南

1-

&
\$

2-

\$ 3

&



3-

5FD>

5FD>

CTRL			
#		ł	\$&H65
\$		Ź	
%		ł	\$&H65
&		Ź	
'		ł	\$&H65
(Ź	
)		63 "Ź#" H ł	"p#" H
*		63 "Ź#" H Ź	
+		#	# \$
#"		\$	# \$
##		@5	
#\$		@5	

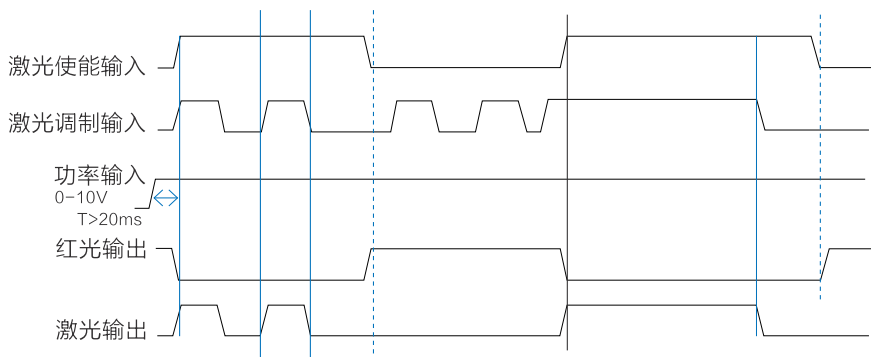

4-

1.

#

\$

%

&

,

(

O++ž .

++ž .

2.

#

\$

%

&

,

A 88

\$"

(
)

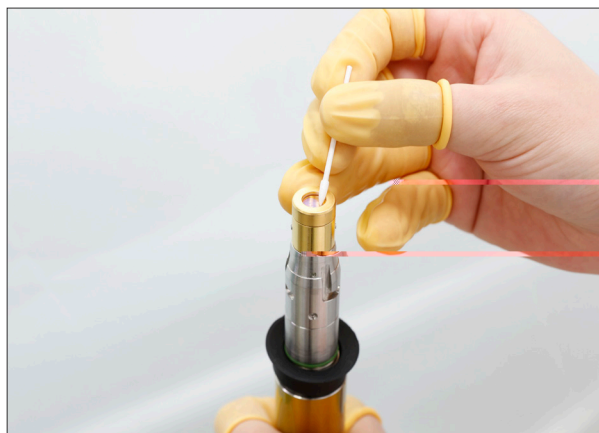
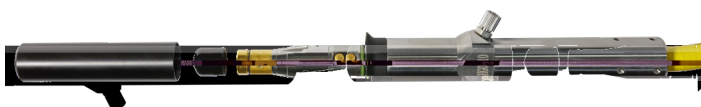

5-

#

\$

%

&

,

(

)

A@

EF3DF

6-

#

\$

"Z#" H

EF3DF

7-

#

G

\$

G

6

这台电脑 > 本地磁盘 (D:) > 上位机 > 半导体专用上位机

名称	修改日期	类型	大小
Max G3_Series - 1.0.0.69 (半导体-厂家版)	2019/6/17 13:22	应用程序	10,149 KB

%

@7F&(j*(j(&Z3^AEZ7@GZYW



&

eWfgb

,



(

B5



)

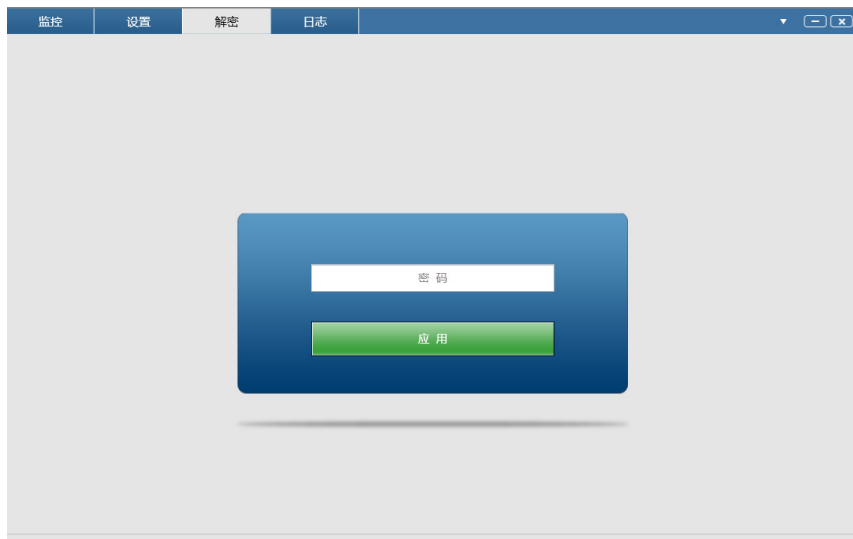

G

第七章 光纤连接器检查和清洁指南

1-

#

\$

%

&

,

(

)

2-

#

A 88

\$

%

) ž#

&

) ž\$

,

(

C 4:

)

) ž%

#&

*



) ž#

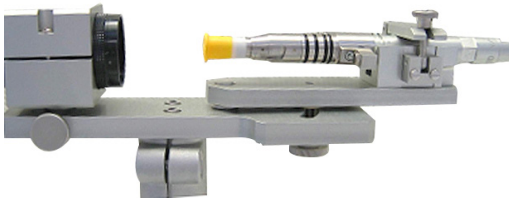

) ž\$

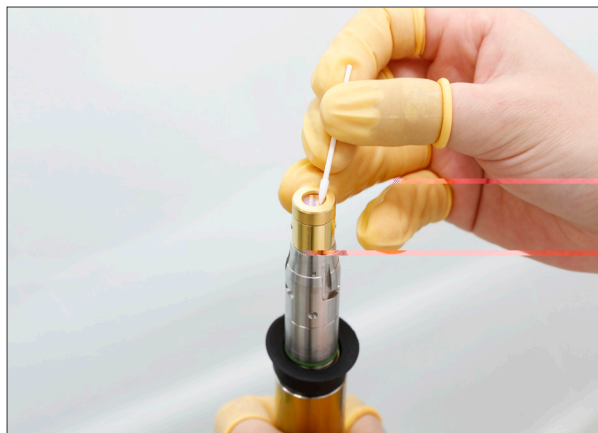

) Z%

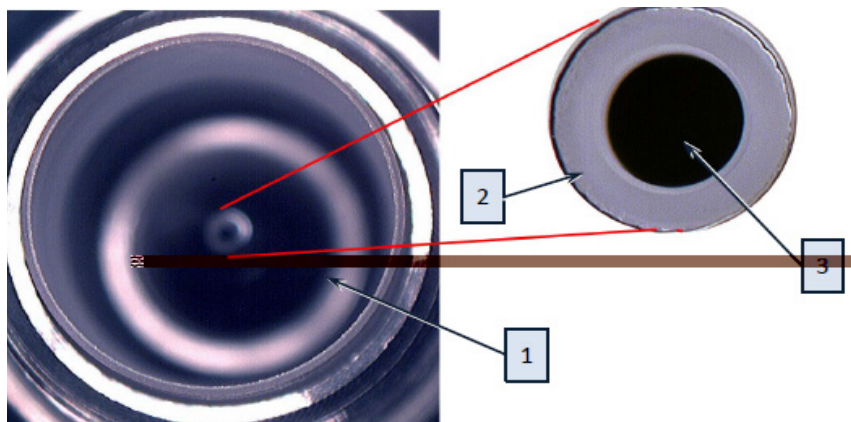

#

\$

%

) Z&

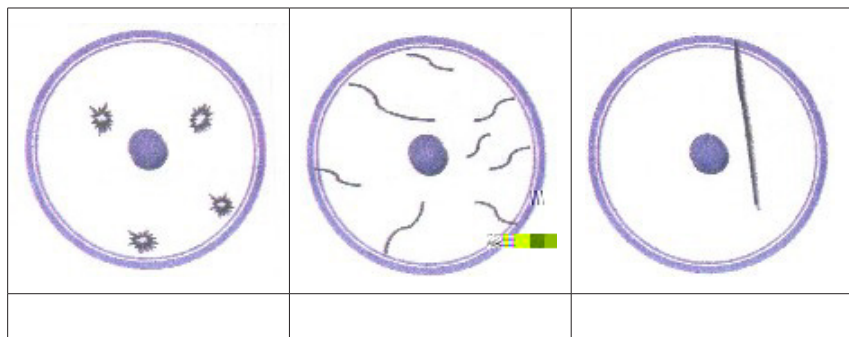

)ž

第八章 加工应用客户操作指导规范

1-

"p' ,

#" ,

' p#" ,

\$,

#" ,

"z\$,

#" p#" ,

2-

C4:

\$

%



C4:

C4:

C4:

!

#" Z#'

#" Z#'

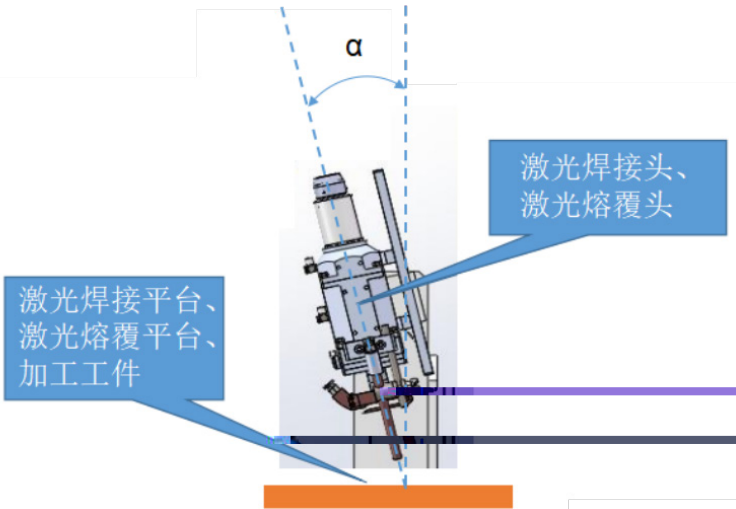

第九章 服务与维修

1-

2-

&" "Ž+" "Ž+' **

第十章 保修声明

1-

2-

\$
%
&
'
(

%#